



EUROBATS



EUROBATS

Publication Series
No

2

Underground sites, such as caves, abandoned mines, fortifications and tunnels, are important habitats for bats right across Europe. In the north, they are used primarily for hibernation as they provide the sheltered conditions bats need. In the south, where underground temperatures are warmer, they are used throughout the year for both breeding and hibernation. The most important sites may be used by many thousands of bats, though sites used by even small numbers can be regionally important.

Unfortunately, many underground sites have an uncertain future. Some are filled in, blocked up or converted for other uses, others are opened for uncontrolled tourism or are heavily disturbed by unauthorised visitors. In some cases, the loss of a single site could affect bats over an area of many thousands of square kilometres.

Recognising the need to conserve and manage these sites, EUROBATS set up a project to catalogue the most important underground sites in Europe and has prepared this practical guide to help Parties and Range States protect and manage them in a way that will take account of the needs of the bats.



Protecting and managing underground sites for bats

ISBN 978-92-95058-02-6
(printed version)

ISBN 978-92-95058-03-3
(electronic version)

Tony Mitchell-Jones • Zoltán Bihari • Matti Masing • Luísa Rodrigues



Mitchell-Jones, A. J., Bihari, Z., Masing, M. & Rodrigues, L. (2007): Protecting and managing underground sites for bats. EUROBATS Publication Series No. 2 (English version). UNEP/EUROBATS Secretariat, Bonn, Germany, 38 pp.

Produced by UNEP/EUROBATS
Coordinator Christine Boye / EUROBATS Secretariat
Editors Christine Boye, Tine Meyer-Cords
Layout Claudia Schmidt-Packmohr

© 2007 Agreement on the Conservation of Populations of European Bats (UNEP/EUROBATS). This publication may be reproduced in whole or in part and in any form for educational or non-profit purposes without special permission from the copyright holder, provided acknowledgement of the source is made. UNEP/EUROBATS would appreciate receiving a copy of any publication that uses this publication as a source. No use of this publication may be made for resale or for any other commercial purpose whatsoever without prior permission in writing from UNEP/EUROBATS.

We would like to express our gratitude to the Department for Environment, Food and Rural Affairs (Defra), UK, and the Ministry of Agriculture, Nature and Food Quality, Department of Nature, The Netherlands, for their funding without which this publication would not have been possible.



Copies of this publication are available from the UNEP/EUROBATS Secretariat
United Nations Campus
Hermann-Ehlers-Str. 10
53113 Bonn, Germany
Tel (+49) 228 815 2420/21
Fax (+49) 228 815 2445
E-mail: eurobats@eurobats.org
Web: www.eurobats.org

ISBN 978-92-95058-02-6 (printed version)
ISBN 978-92-95058-03-3 (electronic version)

Cover photo: Schreiber's bent-winged bats (*Miniopterus schreibersii*), Cyprus.

UNEP promotes environmentally sound practices globally and in its own activities. This publication is printed on chlorine-free, pH neutral, 100% recycled paper, using eco-friendly ink and production practices. Our distribution policy aims to reduce UNEP's carbon footprint.

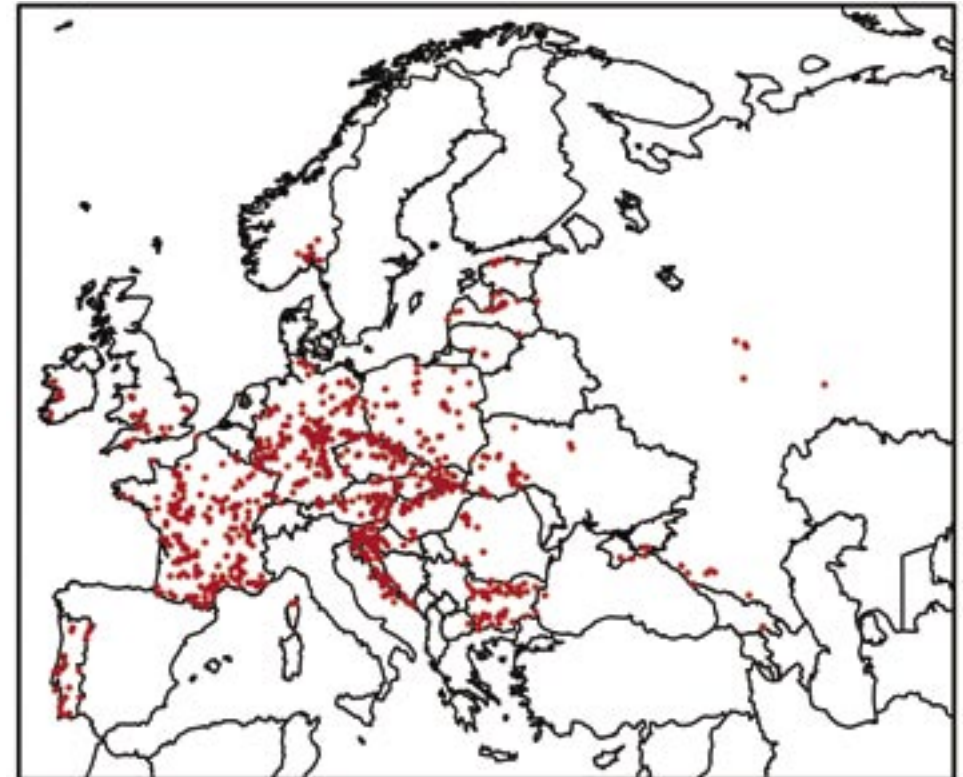

Underground sites important for bats in Europe as identified by EUROBATS Parties and Range States. The map shows the location of sites in the database at 1/11/06.



Contents

1	Introduction	5
2	How bats use underground sites	6
2.1	Characteristics of underground sites	6
2.2	Uses of underground sites	6
3	Threats to underground sites	8
3.1	Excessive disturbance	8
3.2	Destruction, maintenance or change of use	8
4	Site protection	9
4.1	Legal protection	9
4.2	Working with others	9
4.2.1	Working with caving clubs and other underground visitors	9
4.2.2	Site grading	10
4.2.3	Conservation code	10
4.2.4	Site notices	12
4.3	Physical protection measures	12
4.3.1	General considerations	12
4.3.2	Grilles	13
4.3.3	Fences	23
4.3.4	Water barriers	24
5	Site management	25
5.1	Management of the underground environment	25
5.1.1	Rock falls or collapses underground	25
5.1.2	Poisonous gas	25
5.2	Management around the entrance	25
5.2.1	Rock falls and collapses	25
5.2.2	Livestock and large mammals	26
5.2.3	Vegetation	26
5.2.4	Lighting	26
5.2.5	Management of the surrounding habitat	26



6	Creative conservation	28
6.1	Manipulation of air flow and temperature	28
6.2	Reopening of blocked sites	28
6.3	Provision of additional roosting places	30
6.4	Provision of new roosts	30
6.4.1	Cave construction	30
7	Monitoring	36
7.1	Bat monitoring	36
7.2	Physical condition	37
	Glossary	38
	Acknowledgements	38
	Photo credits	38
	Further reading	38

1 Introduction

This manual, produced by the EUROBATS Advisory Committee, provides guidance on all aspects of the conservation and management of underground sites used by bats.

Protecting underground sites requires two elements in combination: legal and administrative arrangements, which help manage the way in which people understand the value and sensitivity of the site, and physical protection measures, which provide security against intruders. Both elements need to be considered together when devising a site management plan or proposal.

Legal and administrative structures, as well as the practice of nature conservation, vary across Europe, so, when dealing with these issues, this guide can only give guid-

ing principles which will need to be adapted to local circumstances. Conversely, the provision of physical protection measures, such as the use of fences and grilles (gates) varies rather less, so some more detailed guidance can be given. Where possible, we have drawn on the practical experiences of bat conservationists from across Europe to provide a range of tried and tested protection structures.

For the purpose of this manual, the term *underground sites* includes caves and all man-made structures that mimic the environmental conditions found in caves. This includes, for example, abandoned mines of all sorts, tunnels, cellars, ice-houses, storage facilities and military installations and fortifications.



3 Threats to underground sites

3.1 Excessive disturbance

Although bats can tolerate a small amount of disturbance during breeding or hibernation and can apparently get used to a low level of human activity, excessive disturbance will cause bats to abandon a site or can be a cause of mortality. In some extensive cave systems, hibernating and breeding bats may co-exist with cavers, who are aware of their vulnerability and take reasonable care not to disturb them. However, bats in many other sites have been adversely affected and some previously important sites have been abandoned. The increasing use of a growing number of sites by outdoor pursuits centres, adventure holiday groups and unregulated tourism is also a cause for concern, as members of such parties generally have less understanding of the impact of humans on these sites and their fauna than members of specialist clubs. Frequency of visits is also a problem: outdoor centres generally operate throughout the week, so that visits to sites by relatively large parties of inexperienced people can be frequent.

Some sites are readily accessible without any special equipment or preparation. Here, casual disturbance by curious tourists can be a problem, as can vandalism, the lighting of fires, the dumping of toxic waste or even the deliberate killing of bats.

3.2 Destruction, maintenance or change of use

Subterranean sites can suffer from a variety of operations that can affect their use by bats. Safety considerations and concern over legal liability have persuaded many local administrations, national mining authorities or land owners to seal disused shafts and, in some cases, block caves or passages in ways that make them inaccessible to bats. Even if sites remain accessible, partial blocking or obstruction can alter the airflow, leading to temperature changes within the system. In some areas the loss of potential hibernation sites is continuing at a significant rate. Tunnels have been repaired, converted to storage areas or rifle ranges, or reopened for their original use; caves have been opened for public access as show caves, and caves and mines have been quarried away as part of commercial quarrying operations. Even if a cave or mine is to remain open, gating or grilling in an inappropriate way can also affect the bats, so the SNCO¹ should always be consulted.

Even quite small changes to the topography of a site, both inside and outside, can have far-reaching effects on its suitability for bats, mainly by altering the air-flow through the system and hence the temperature and humidity. Some changes, if carefully planned, can benefit the bats, but others can certainly degrade the usefulness of the site.

¹ Statutory nature conservation organisation – see Glossary, p.38.

4 Site protection

4.1 Legal protection

Bats have some degree of protection in every country in Europe, though the details of this, and the extent to which the legislation is enforced is very variable.

In the European Union, protection is given to bats and the places they use for breeding or resting by Council Directive 92/43/EEC of 21st May 1992 on the Conservation of Natural Habitats and of Wild Fauna and Flora. All species of bats are on Annex IV *Animal and Plant Species of Community Interest in need of Strict Protection* and some are also on Annex II, requiring the designation of Special Areas of Conservation. Member States are obliged to translate these requirements into their own national legislation which complies with the Directive.

Many European countries are also signatories to the Bern Convention, which requires strict protection measures for species listed on Appendix II. This includes all bats except *Pipistrellus pipistrellus (sensu lato)*, which is listed on Appendix III. Details may be found on the website of the Bern Convention.

Those countries which are Parties to the Agreement on the Conservation of Populations of European Bats (UNEP/EUROBATS) assumed special obligations for the conservation of bats and their habitats. This included a recognition that protection and monitoring of important underground sites are essential for bat conservation.

Most EUROBATS Parties have also joined the Bonn Convention (UNEP/CMS). This Convention lists all bat species on Appendix II, indicating that they are migratory species which may be subject to Agreements.

Many species of bats are red-listed by the IUCN because of their poor conservation status. Although listing does not carry any legal requirement for protection, it is used by many countries as an important criterion when deciding which species to protect.

4.2 Working with others

4.2.1 Working with caving clubs and other underground visitors

Patterns of land ownership vary across Europe, with some underground places privately owned and others owned by the state. In many countries, however, organised caving or mine history groups or clubs² have an important role in protecting such places and regulating the number of visitors. Access to many caves and mines is restricted for safety reasons, to keep out mineral collectors, to protect the underground features or to safeguard a water supply. Caving clubs may hold the keys to gates, grilles or fences and regulate the number of visitors according to an agreement with the owner or the state.

Because caving clubs and other responsible organisations have an interest in protecting the underground features, including fauna, of caves, it is very important that bat conservationists and these clubs work together and that underground places are protected with the agreement of both parties.

² This includes organisations with an interest in abandoned mines, fortifications and other underground structures.



All caving clubs have systems for training their members to work in a safe way and to protect the underground environment. This provides an important way for bat conservationists to explain the vulnerability of bats to disturbance and the actions that cavers should take to protect them.

4.2.2 Site grading

To assist relations with caving organisations, it is important that bat conservationists do not demand unnecessary restrictions on the activities of cavers and that any restrictions on where and when cavers can visit underground sites are fully justified and explained. One way of doing this is to develop a grading system for caves. The way in which this is done will need to fit with the national approach to cave ownership and exploitation, but a typical system would include grades for sites with different levels

of bat interest and hence different degrees of restriction on caving activities. An outline example system is shown in the table below.

4.2.3 Conservation code

Developing a conservation code, setting out the reasons why bats need special care and how visitors to underground sites should behave, is an important step in developing relationships with other visitors to these sites. It is important too that batworkers should respect other conservation interests, such as rock, mud and flowstone formations in caves and historical artefacts in mines and other artificial sites. An example conservation code, based on one used in the UK, is shown on page 11. This may need to be adapted to local conditions, but most of the main elements about contact with bats should be kept.

Grade	Bat interest	Advice to cavers
1	No known interest	No restrictions on visiting. Report any bat sightings to bat contact.
2	Small numbers of bats	No restrictions on visiting. Follow the conservation code.
3	Large numbers of bats present seasonally	Seasonal restrictions on visiting agreed. Do not visit defined parts of the cave during the closed season, follow the conservation code at other times.
4	Large numbers of bats present throughout the year	Cave closed all year. Small parties of visitors may be permitted by agreement. A management plan can indicate limit to numbers and the routes to be used.

Example Bat Conservation Code

Caves and mines, their formations, artefacts and fauna, are all part of our national heritage. All visitors to underground sites should work to maintain these sites for current and future generations.

Always follow the safety and conservation codes published by the caving and mining history organisations and liaise with local groups over access and safety requirements.

Remember also that bats need your help to survive the winter. Most hibernating bats are very difficult to see as many squeeze into cracks and crevices. Just because you cannot see them does not mean they are not there!

Those visiting known bat sites for purposes such as recreation, are asked to observe the voluntary conservation code and respect any special restrictions that have been placed on particularly important bat sites. Because disturbance can be so damaging, the study of bats in underground sites is limited to appropriately trained and authorised people. Such authorisations are issued for controlled, carefully considered basic survey and monitoring and occasionally for scientific research.

Contact with bats

- Do not touch or handle bats (unless licensed and then only when essential). Also beware of dislodging bats from their roosting position particularly when you are moving through low passages.
- Do not photograph roosting bats. Flashguns can be very disturbing.
- Do not warm up hibernating bats. This can arouse them. Try not to stand underneath them or linger in confined spaces as even your body heat is sufficient to cause arousal.
- Do not shine bright lights on bats. Both the light and the heat can trigger arousal.
- Do not use carbide lamps or other open flames in bat roosts. Carbide lamps are particularly undesirable because of the heat and fumes.
- Do not smoke or make excessive noise underground. Any strong stimulus, including cosmetics with strong smells, can arouse bats.
- Do not take large parties into bat roosts in winter. Rescue practices should also be avoided when bats are present.
- Do not light fires in the entrance to underground places as the smoke may arouse the bats.
- Do seek advice before blasting or digging. Explosives can cause problems both from the blast itself and from the subsequent fumes. In known bat sites blasting should be limited to the time when bats are not present or to areas not known to be used by bats. Digging operations may alter the microclimate of bat roosts.

Source: Adapted from Hutson, A. M., Mickleburgh, S. & Mitchell-Jones, A. J. (1995): Bats underground: a conservation code. Bat Conservation Trust, London.

4.2.4 Site notices

Although bat conservationists often prefer to keep the location of important sites secret, it can be helpful to place notices behind grilles or fences to explain why the site has been protected against unauthorised entry. This requires discussion with the landowner and an assessment of the risk of vandalism. If there is concern about publicising the presence of the bats, an alternative approach is to put up a notice explaining that the site has been closed for safety reasons. If the site is only protected for part of the year (perhaps by agreement with caving organisations), a notice should explain this and indicate when the roost is open to visitors.

Some important caves are subject to disturbance by casual tourists because their entrances are close to a signposted public footpath. Rerouting the path and relocating the signposts can give some protection from disturbance.

4.3 Physical protection measures

4.3.1 General considerations

The most frequently required conservation measure for caves and mines is physical protection against excessive disturbance. This is generally achieved by fitting a grille across the entrance which permits the free passage of bats but not people, though other measures such as security fencing may be needed in some cases. If a grille or fence is to be fitted, it is important to monitor bat numbers before and after fitting to check for any beneficial or adverse effects.

Some species of bats react negatively to the presence of grilles. This is the case with *Miniopterus schreibersii* at all times of the year and *Rhinolophus mehelyi*, *R. euryale*

Myotis myotis and *M. blythii* during the breeding season. Observations at sites in Portugal and France showed that:

- at least in the short or medium term bats abandon gated caves,
- flying speed decreased,
- flying height decreased,
- number of circles near the entrance increased, and
- the number of landings on the ceiling, walls or even on the gate increased.

Taking these results into account, grilles covering the whole entrance are not a suitable measure to protect roosts that are used by large colonies of these species at the times referred to above; fences or other security measures should be used instead. Special care should always be taken when protecting sites used by summer colonies as the frequency with which bats pass through the grille is likely to be much higher than at sites that are used only during the winter. At summer sites, individual bats may pass through the grille several times per night whereas at hibernation sites they may only pass through the grille once or twice per month. Sites used for autumn swarming should be treated as summer sites because bat activity may be very high for a short period of the year.

Grilles or fences must be carefully planned if they are to be successful and a number of points must be taken into account.

- The regional or national nature conservation organisation (SNCO) must be consulted if the site is already used by bats. Grilles or fences have the potential to damage bat roosts if not correctly designed and fitted, so advice must be sought on this. The SNCO may also wish to keep records.

Grilles and fences can be expensive items and the SNCO may be able to assist with the cost of protecting known bat roosts and suggest other sources of funding.

- The species using a site throughout the year should be identified before protection is installed as some species are known to avoid flying through grilles so fences must be used instead. Summer as well as winter use should be taken into account, so these data may take some years to collect. Protection should not be installed at times when disturbance to bats is likely to result.

- The impact of the grille or fence should be considered beforehand. For very important sites this could be studied by using a temporary installation (e.g. a plastic grille). The level of use by bats (frequency of entry and exit) should be checked after installation.

- Permission must be sought from the landowner and any tenants. A management agreement will help to set out responsibilities and any arrangements that have been made for access. Many owners will welcome the installation and maintenance of a grille or fence, as this will help to reduce fears about safety and discourage trespass. Many conservation NGOs³ have experience of such agreements and they may be willing to help.

- If the site is used by cavers, mine historians or similar groups, suitable arrangements for access by these groups must be negotiated before any work begins. Failure to do so will severely upset relations with responsible caving groups and may also

lead to repeated damage or destruction of the grille or fence.

- In high-risk urban sites, frequent or continuous monitoring of a grille or fence may be possible using a professional security service, intruder detection systems or even CCTV.

4.3.2 Grilles

To be effective and secure, grilles should have horizontal bars of appropriate design and construction for the site. The following points should be taken into account:

- The bar spacing is one of the most important variables, as some bats, particularly horseshoes, are known to be reluctant to fly through narrow gaps. An air space of 150 mm between horizontal bars is recommended, but this may be large enough to allow children through. Therefore a slightly narrower spacing may be appropriate for some sites or for some lower parts of a grille or where there are legal requirements for narrower spacing. A 130 mm gap seems to be a reasonable compromise for these areas, though this spacing has been shown to affect the behaviour of *Myotis* bats at one swarming site in Britain.



Grilled mine near Oslo, Norway. Used for hibernation by small numbers of bats.

³ Non-governmental organisations - see Glossary, p. 38.

When specifying the design, make sure that gap between bars is correctly described as engineers normally specify distances as between centres. For example, using 20 mm diameter reinforcing rod (radius = 10 mm) a 150 mm air gap between bars would need a 170 mm gap between centres. This can be an expensive error!



Grilled stone mine, Kent, UK. An important local site.

- If horizontal bars are between 130-150 mm apart, vertical supports should be more widely spaced, though too wide a spacing will make the grille vulnerable to vandalism as the bars can be forced apart more easily with tools such as car jacks. The exact spacing can be chosen to suit the size of the grille but should be in the range of 450-750 mm, with greater horse-shoes being given the larger spacing.



Grilled chalk mine, Norfolk, UK.

- All grilles should be constructed to permit access for authorised persons and for safety. For small entrances, it may be most convenient to have the whole grille hinged and fitted on a sub-frame. This is particularly appropriate when doorways have to be gridded, as the sub-frame, hinges and lock can be concealed behind the door frame. Larger grilles will need to be fixed permanently in position and fitted with a door of at least 500 x 500 mm. This can be either hinged or sliding, depending on the circumstances. If hinges are fitted, these should be of robust construction or concealed so that they cannot easily be cut through.



Small grilled mine in sloping ground, UK.

- The lock should be the weakest part of the grille so that a determined intruder may be tempted to break this relatively cheap and replaceable component rather than the grille itself. However, it should not be made too vulnerable and should be fitted so that it cannot easily be cut or levered off, though if the lock becomes seized or someone damages it or fills it with epoxy resin it needs to be accessible for replacement. An alternative approach, which has been used in some situations, is to conceal the lock, so an attacker is unclear where to begin an assault.



Large grilled mine, S. Limburg, The Netherlands.

- The construction material should be chosen to suit the vulnerability of the site and the finance available. For sites where there is a low risk of vandalism, a grade of mild steel may be an appropriate material. This is cheap but is not resistant to cutting and rusts rather quickly. Its main advantage is that the grille can be cut and fitted *in situ* and welded with portable equipment. For sites at higher risk or where the grille is to be prefabricated, some form of toughened steel should be used for those



Large-section grille, Lambertsberg, Germany.

parts of the grille that are most at risk. Reinforcing rod (rebars) of 20 or 25 mm diameter is readily available and provides reasonable resistance to rust and to hacksaws. Tougher steels, such as manganese alloys, are available, but these are generally expensive and some can be difficult to cut and weld. Seek advice about suitable grades from a steel supplier or fabricator. For particularly high-risk sites, it is preferable to construct the grille with 100 mm diameter steel tubes (thickness 8 mm) filled with concrete, pebbles and reinforcing rod (Figure 2). This is resistant to cutting with power tools and bending, even with a strong jack (see www.cpepesc.org/article.php3?id_article=354).



High-security entrance door, Gauberg, Germany.

Alternatively, grilles can be constructed from large-section angle iron which looks so massive as to deter attack, though care should be taken not to affect the air-flow. Small and medium-sized grilles can generally be prefabricated out of a mixture of rod and angle and then trimmed to size, if necessary, on site. Large grilles may need to be prefabricated in sections and then bolted or welded together as they are fitted.

- It is often advantageous to protect grilles against rust. This is preferably done by galvanising at the time of manufacture (a hot-dip process) or by coating the grille with an anti-rust preparation such as 'Norusto' or 'Nutrust'. Epoxy resin paints may also be used, but paints with a persistent smell, such as bitumen, should be avoided.
- By careful design and construction it is possible to make a grille that is extremely strong and resistant to damage. However, it must be remembered that no grille can be proof against powerful welding or cutting equipment and that a prolonged and determined attack will eventually breach any

grille. Repair costs are likely to be proportional to the cost of the original grille. It is best to site the grille where it is visible from outside the cave or mine so that potential vandals are deterred.

- The grille must be fitted so that it does not impede air flow into the site. It is generally inadvisable to fit the grille into the narrowest part of an entrance, where it could critically affect air flow. If the narrowest point is the only logical place to put the grille, for example in a doorway, care must be taken to keep the obstruction to a minimum, particularly at floor and roof level.

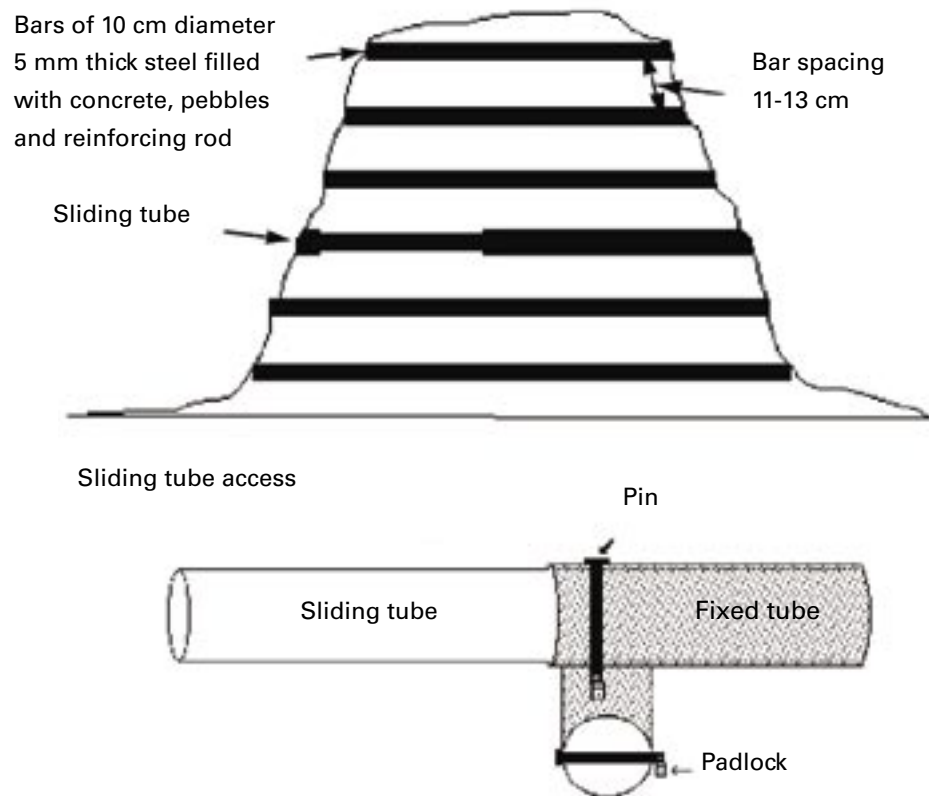

Figure 2. Grille design used in France. The tubes are filled with pebbles, steel and cement, which provide good resistance to cutting.

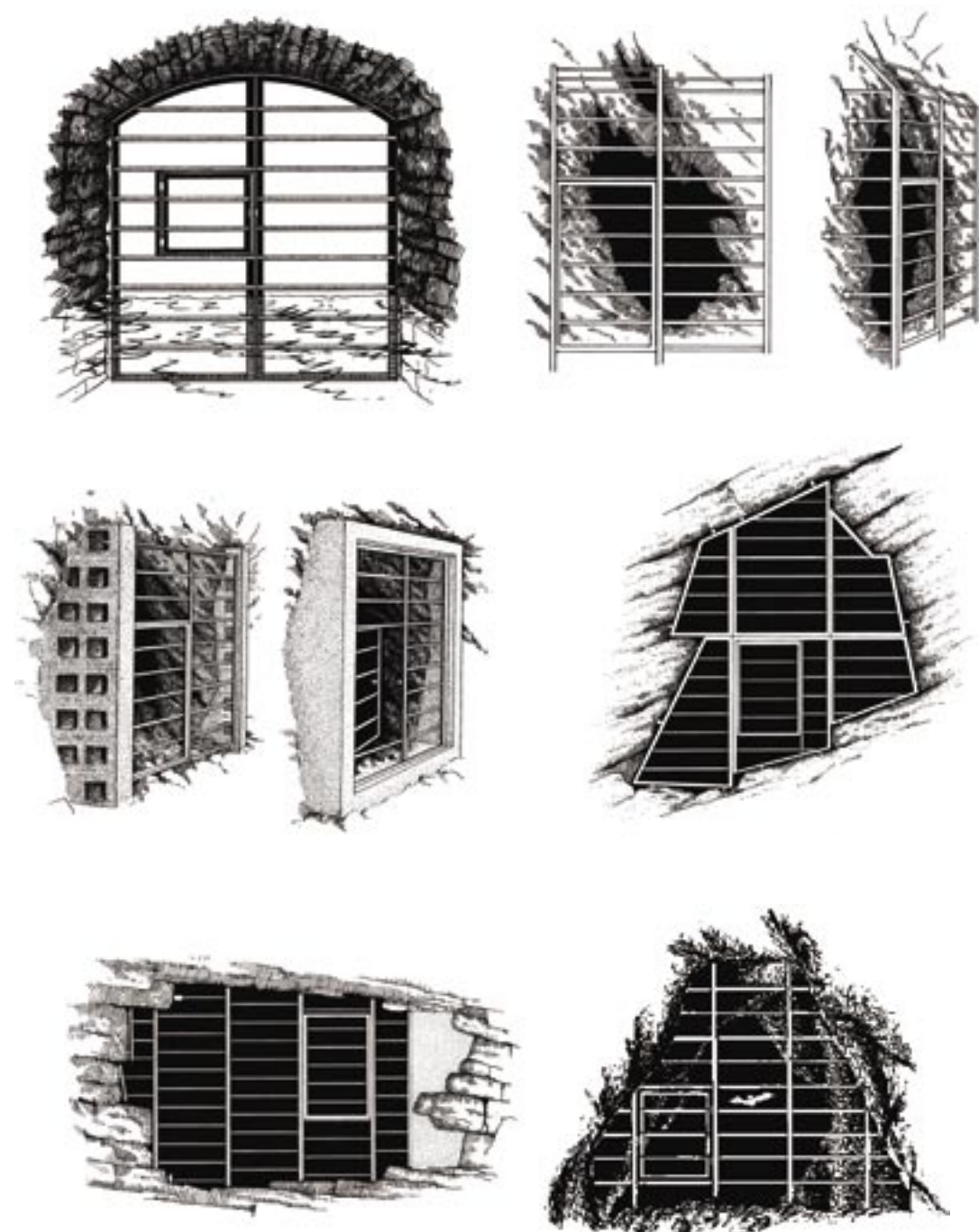

Figure 3. Examples of grilles fitted to horizontal entrances. Grilles can be made oversized and pinned to the rock face, fitted inside the entrance using bolts or pins or built into blockwork to square up and stabilise the entrance. Large grilles can be constructed off-site in sections and bolted or welded on site. A lockable entrance door should always be fitted.

- The grille must be securely fitted into solid rock, if available. It is no use fitting a carefully constructed grille, only to have it dug round or pulled out. A common method of fitting is to drill a series of holes around the entrance and cement in steel rods which are then welded to the main grille. This is not always a convenient method as it requires the use of on-site welding equipment of adequate power and it is rarely possible to weld large-section high-carbon steel with a portable welder. An alternative is to fit the grille with lugs or a rim of steel angle and then pin it to the wall with rock-bolts. The heads of the bolts can then be rounded off or welded to the frame for additional security. Hard rock sites need only relatively short bolts, but sites in chalk or other soft strata may need long auger-type bolts screwed up to 900 mm into the rock. Sites with unstable or awkwardly shaped entrances may need a concrete or block surround to be built in place before a grille can be fitted. In very poor ground conditions, it may be preferable to create a new site close by rather than try to grille a system that would soon collapse anyway.

- In most cases, the base of the grille should be set into concrete cast into a trench cut into the floor of the site. Care must be taken that the original floor-line is preserved so that air flow is not impeded. The trench should be a minimum of 300 mm deep, otherwise intruders may tunnel underneath. In soft earth or clay, it may help to hammer rods vertically into the earth at the bottom of the trench and set their tops into the concrete. At smaller entrances it might be better to use a door with small (letter-box) type access.

- The grille must be inspected regularly and maintained when necessary. A strongly made grille in a low-risk area is unlikely to need repair for many years but should still be inspected regularly. In high-risk areas, the prompt repair of any damage will eventually discourage intruders who discover that they have to work hard to gain access at every visit.

- Grilles over vertical shafts may need to be fitted on top of a low structure to raise them sufficiently far off the ground so they do not trap animals or leaf litter. Bats seem to be able to fly through horizontal grilles without difficulty although some designs have attempted to provide a vertical grille in the side of a structure.

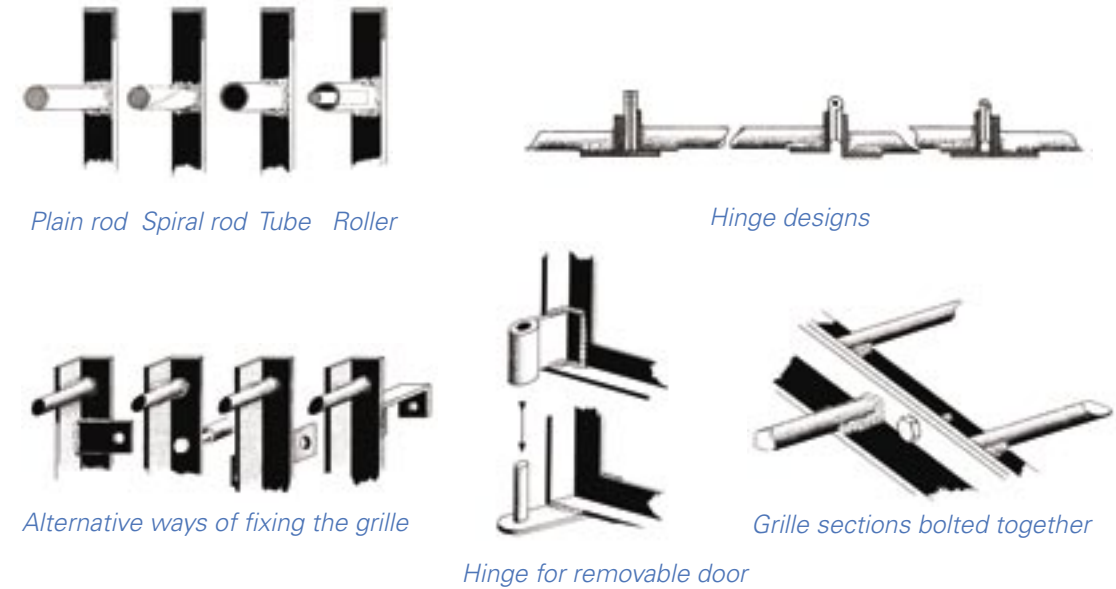

Figure 4. Grille fabrication details.

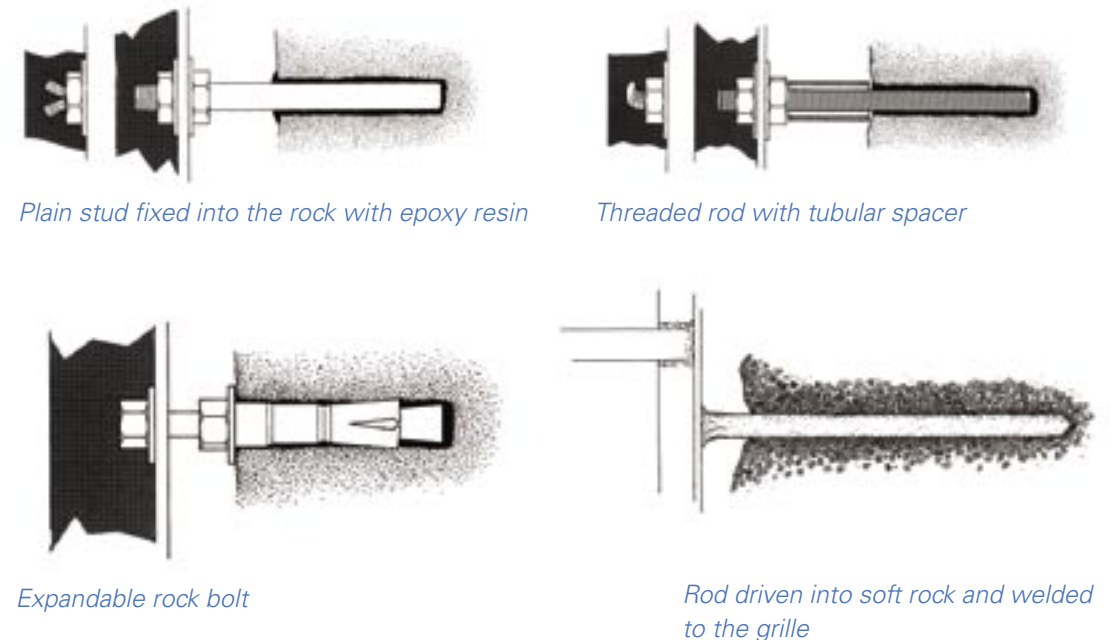

Figure 5. Methods for fixing grilles in position. If bolts are used, the protruding end should be split, spread or welded to prevent easy disassembly.

Case study

Greywell Tunnel, Hampshire, England

This brick-lined canal tunnel collapsed many years ago, leaving one water-filled end of about 800 metres and one of about 100 metres. The longer end connects with the remaining canal whilst the shorter end opens into woodland and a dry canal bed. The importance of the site for hibernating bats was first realised in the mid-1970s and counts of hibernating bats in the longer end of the



Greywell canal tunnel grille.

tunnel have been carried out in most years since that time. The majority of the bats are *Myotis nattereri*, with a small number of *M. daubentonii* and an occasional *M. mystacinus/brandtii*. In 1985, the tunnel was grilled to prevent unauthorised access.

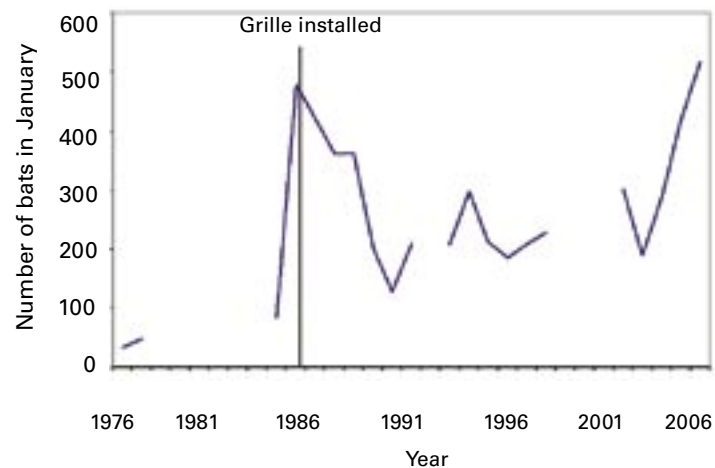

Figure 6. Natterer's bats in the Greywell Tunnel, UK. Natterer's bats (*Myotis nattereri*) make up more than 90% of the bats counted, the remainder being Daubenton's bats (*M. daubentonii*).

The grille was constructed from steel reinforcing rod with a diameter of 25 mm and an air-gap between bars of 170 mm. It was fully galvanised after construction and was fitted by bolting it to the tunnel walls.

Although there are relatively few data available before the fitting of the grille, there is no indication that the number of bats has been significantly affected. There was a decline in numbers during the 1990s, but a closer examination of the data suggest that there is a strong relationship between winter temperature and the number of bats and that the 1990s was a period with mild winters. More recently, numbers have increased,

with a record number counted in January 2006. The site is also used for autumn swarming by a variety of species, some of which have not been recorded hibernating there. During September and October specimens of *M. nattereri*, *M. daubentonii*, *M. mystacinus*, *M. brandtii*, *M. bechsteinii*, *Plecotus auritus* and *Pipistrellus pipistrellus* have been trapped at the entrance to the tunnel.



Entrance to Greywell canal tunnel.

Source: A. J. Mitchell-Jones, Natural England, UK.

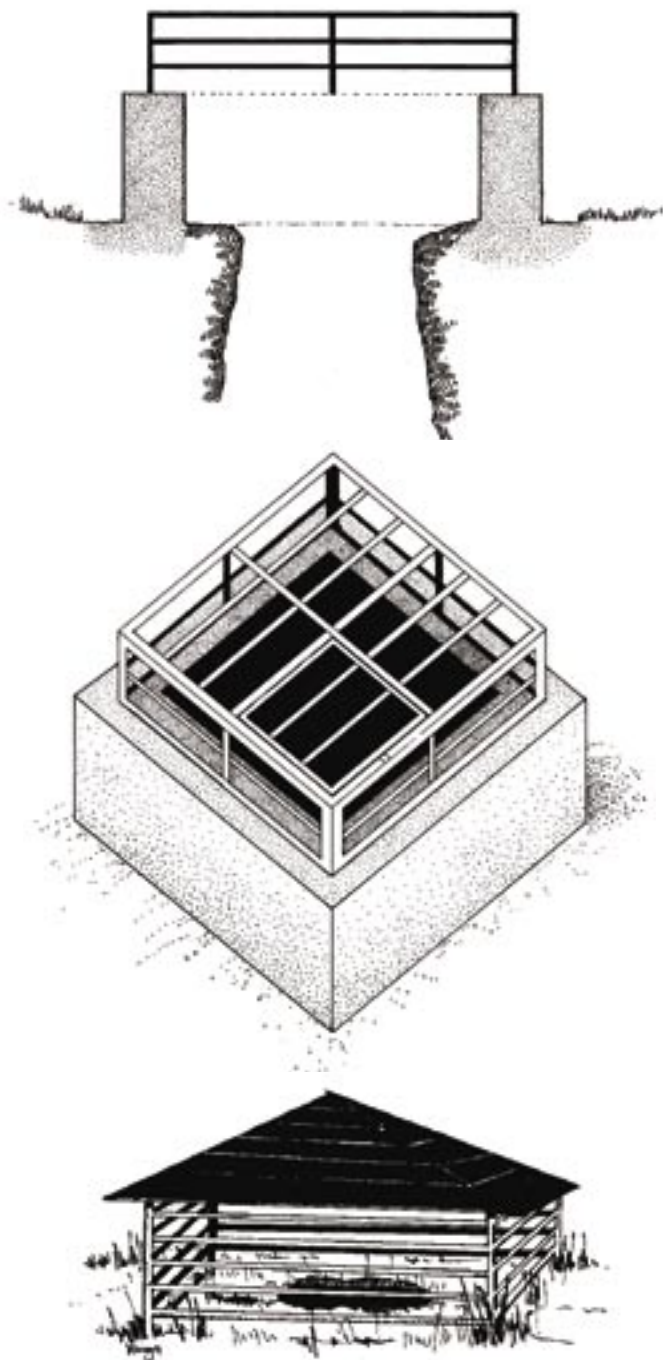

Figure 7. Grilles for vertical shafts. Horizontal grilles close to the ground should be avoided as these create safety problems and can be blocked by vegetation. Stabilisation of the top of the cave or shaft may be needed. Bats seem to have no difficulty flying up vertical shafts and then through a vertical grille.

4.3.3 Fences

Security fences are generally less effective than grilles at deterring intruders, but may be the only option in some circumstances, for example at sites of species known to react negatively to grilles. Many different types of security fence are available, with welded steel mesh probably providing the best resistance to cutting for little more cost than steel lattice, which is easy to cut.

- If possible fences should be placed at least 5 m away from the opening to avoid obstruction the bats' flight route. Vertical bars should be 2.5 m high and end with a 25 cm spike turned outwards.
- Fences should never have barbed wire as bats can get stuck to it.
- The base of the fence should be set into a trench at least 100 mm deep cut into the floor of the site, which is then backfilled with concrete.



Security fence, France.



Fenced enclosure around an important mine, Portugal.



Door in fence, Portugal.



Fenced mine, Croatia.

General plan

Dimensions in metres

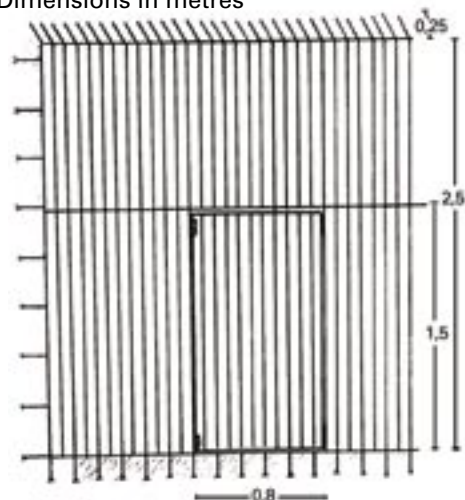
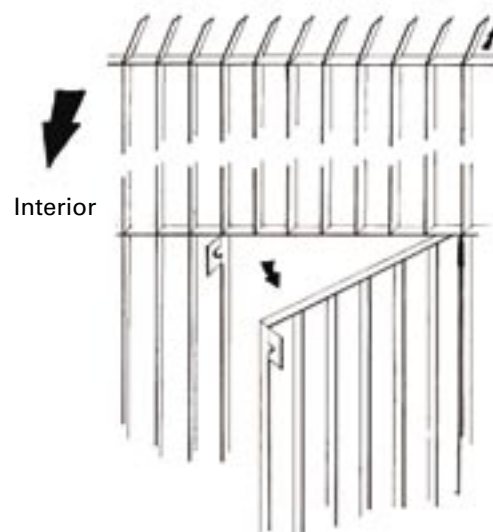
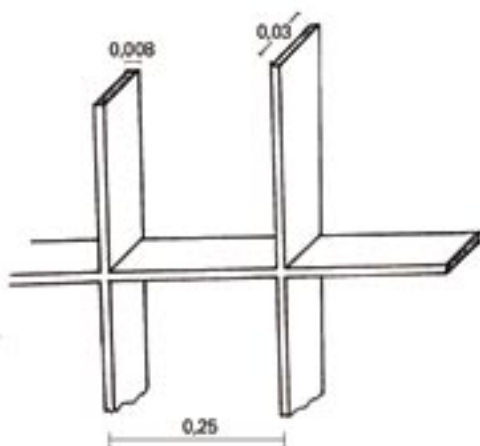
*Security fence: general layout.**Detail: orientation of the door and the ends of the bars.**Details of bar spacing.**Figure 8. Security fence construction.***4.3.4 Water barriers**

Pools of water around the entrance and inside underground sites can be very effective at deterring casual intruders, though they are not effective at keeping out speleologists, who are usually equipped for entering wet sites.

If water is available at the site, it may be possible to dig shallow pools or create low dams to ensure at least a few centimetres of water (or mud) block the entrance at the time of year when bats are present.

5 Site management

5.1 Management of the underground environment

Apart from the management of visitors, the underground environment of caves is unlikely to need any environmental management and in fact this could be damaging to other conservation interests. If proposals to alter the underground environment of caves is being considered it would be important to consult widely before undertaking any work.

Abandoned mines and other man-made structures may be more unstable and there may be occasions when works are required to maintain the underground environment or remove threats to the site.

5.1.1 Rock falls or collapses underground

Unless a rock fall threatens to block a significant proportion of a nationally or internationally important underground site, it is unlikely that action to prevent the fall can be justified. The significant safety hazards associated with working underground and the high costs of remedial works would generally rule out such action. If action is under consideration a qualified and experienced engineering geologist should be employed to advise on the most cost-effective solution.

5.1.2 Poisonous gas

Although uncommon, there are some instances of bats dying because of accumulations of poisonous or asphyxiating gas in

abandoned mines. This usually occurs where heavier than air gas accumulates behind a blockage. Removal of the blockage may be possible, but requires careful attention to safety procedures. An alternative solution is to close off the mine (or section of mine) to prevent further bat deaths.

5.2 Management around the entrance**5.2.1 Rock falls and collapses**

At some sites the nature of the rock may lead to an increased possibility of roof falls or collapses.

This is more likely to be a problem at abandoned mines than caves, which tend to be more geologically stable. Problems can be made worse by large trees growing in the rock face or by water running down the surface.

There are many possible solutions to these problems and it is advisable to seek advice from an engineering geologist. Typical solutions include:

- Removal of overhanging trees and loose rock.
- Rock bolting to stabilise loose or unstable rocks.
- Steel netting bolted to the rock face above the entrance to prevent rock falls.
- Concrete or blockwork to support and strengthen the entrance.
- Large-diameter concrete pipes inserted into the entrance and consolidated with rock or rubble.

5.2.2 Livestock and large mammals

Cave or mine entrances can provide attractive sheltering areas for livestock or large wild herbivores which may cause disturbance to bats or later the internal environment of the site. Simple barriers or fences may be required to exclude large animals from this area.

5.2.3 Vegetation

The management of vegetation around the entrance to underground sites needs to strike a balance between providing vegetated and sheltered flight paths for the bats and preventing the vegetation from blocking the entrance and either affecting the bats or obstructing the airflow. In general, the aim should be to maintain as much vegetation around the entrance as possible in order to provide the bats with sheltered flight paths. Removal of vegetation should take a minimalist approach (but for trees see 5.2.1).

5.2.4 Lighting

Increases in artificial light levels around the entrances to underground sites, or along flight routes that bats use to reach them, may affect the movements of bats to or from the site and should be avoided. If an increase in artificial lighting is unavoidable, perhaps because of new buildings or street lighting, efforts should be made to preserve dark flight routes for the bats.



Trimming vegetation around a mine entrance, Portugal.

5.2.5 Management of the surrounding habitat

External activities, such as burning vegetation or storing volatile liquids, which could affect the internal microclimate of the site, should be controlled where possible.

Case study Király-bányák mines, Hungary

Mines are often threatened by the collapse of their entrances, which makes them useless as bat roosts. Stabilisation of the entrances can maintain their usefulness and the work can be combined with other improvements to the site, increasing its value to bats.

In Király-bányák mines, four straight tunnels 10-40 metres long were close to collapse. During the summers of 2003 and 2004 strong new entrances were built. Each entrance arch is 6 metres long and has two staggered cross walls which extend from the side of the tunnel to beyond the centre. These darkened walls keep out the light and also increase the temperature inside the mines. Since then, the number of bats (*Rhinolophus hipposideros* and *R. ferrumequinum*) has increased and new species (*Barbastella barbastellus* and *Plecotus auritus*) have been seen.



Király-bányák mine entrance before reconstruction.



Király-bányák mine entrance after reconstruction and improvement.

Source: Z. Bihari, Hungary.



6 Creative conservation

Many subterranean sites are potential bat sites but are unsuitable for one reason or another or are suitable for improvement, as measured by the numbers of bats recorded as roosting there. Protection from disturbance has already been dealt with, but other measures which may be taken are described below. In all cases, a detailed impact assessment should first be carried out, perhaps including experiments with temporary barriers.

6.1 Manipulation of air flow and temperature

Largely static cave or mine systems with little air movement are often too warm for most species for hibernation and can be improved by the creation of additional entrances or air vents, so as to increase the proportion of the system subject to a dynamic air flow. In northern and central Europe, the aim is to achieve an internal temperature of 0-9°C in January during frosty weather, but in southern Europe, temperatures of up to 12°C at this time of year are appropriate. In all cases, the ecological requirements of the species of bats in the area must be taken into account. If such manipulations are attempted, the numbers and positions of hibernating bats must be monitored carefully to try to gauge the success of the project. In contrast, tunnels which are open at both ends fluctuate too much in temperature and are too dry for bats. They can be improved by fitting partial barriers at the ends or in the middle of the tunnel. The resulting decrease in air flow allows the temperature to rise towards that in a similar static system.

Simple straight levels, adits (drainage passages) or tunnels with a relatively high passage and entrance are often very suitable for bats because, though there is no through draught, the relative stability of the cave temperature in the tunnel can give rise to convection currents and a dynamic air flow (see Figure 9). Such currents can be prevented by mounds of rock or earth at the entrance, and it may be advantageous to clear these.

6.2 Reopening of blocked sites

Many subterranean sites have become unavailable to bats either through deliberate blockage or through collapse. These include caves, mines, tunnels, grottoes, ice-houses, lime-kilns and cellars. The reopening of such sites can lead to their rediscovery by bats and re-establishment as hibernacula. Before such work is undertaken, the permission of the landowner must be sought and it may be necessary to enter into an agreement over the long-term protection of the site. Immediate grilling, or other ways of preventing human access, is usually a condition of reopening what might be regarded as a dangerous place.

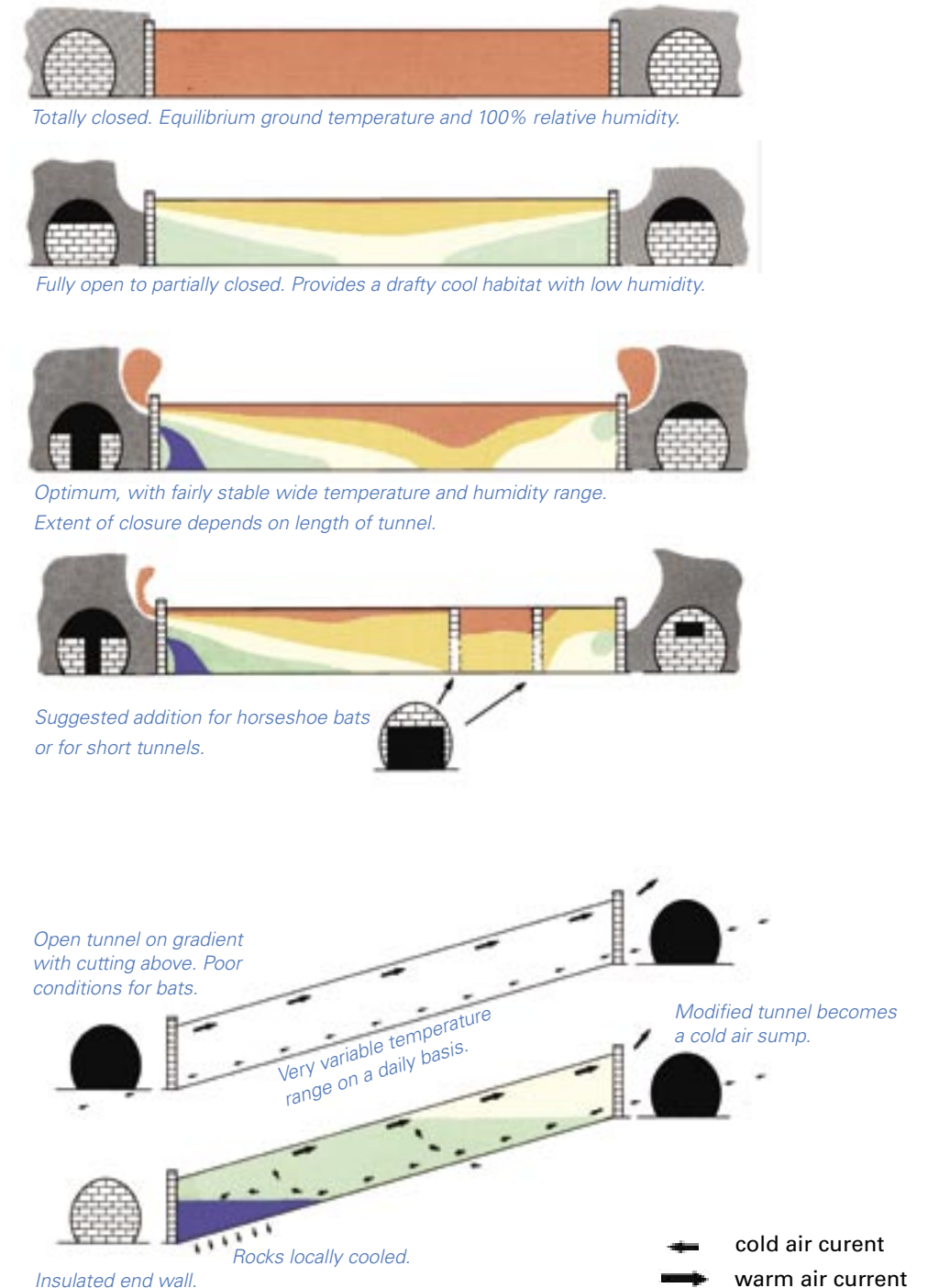

Figure 9. Winter air flows and temperatures in tunnels can be controlled by the design of the end walls. The warmest areas are illustrated in red, the coolest in blue.



6.3 Provision of additional roosting places

Although bats can hang on to surprisingly smooth surfaces, many species prefer to roost in cracks or crevices, particularly in cold areas or where airflow is high. Some sorts of artificial tunnels or natural caves are lacking in these, and the provision of additional places can sometimes increase the attractiveness of the site to bats. Bats will roost in almost any sort of crevice, and successful devices have ranged from planks of wood leaned against the walls to loose piles of bricks, bat-bricks or building blocks.

6.4 Provision of new roosts

Some areas have very few underground sites, either because there are no natural caves or there is no history of mining in the area. Others have tunnels in soft or dangerous strata. Both could provide suitable sites for artificial roosts. The positioning of new sites and the design of the structures are fundamental to their success and some suggestions for the manipulation of air flow are given in Figure 9.

A specific example, the conversion of a pill-box, is illustrated in Figure 10 and many of the techniques used here can be applied to other types of site.

It should be remembered that many important bat sites across Europe are man-made, mostly as the products of former mining or military activities, and that their use by bats may take many years to develop. Site protection of a new roost is vital from the start, both from the point of view of ownership of the land and from site disturbance. A design life of 100 years should be planned and professional assistance should be sought at all stages.

The costs incurred in building new sites are high, but funds from mandatory or voluntary mitigation works and suchlike are available from time to time.

6.4.1 Cave construction

About two dozen purpose-built bat caves have been constructed in the UK, many of these of concrete pipe construction with added brickwork. The success rate (occupancy rate) has so far been poor, although their use will almost certainly increase over time. Creating the precise environmental requirements (particularly with regard to humidity) for bats in a purpose-built roost site is difficult particularly when so little is known about what those requirements are. Over time, as our understanding of different species needs improves it is likely that designs will reflect better the needs of bats and consequently be more successful.

The Bat Conservation Trust holds information about many of the projects undertaken to date and some of the projects have been reviewed in 'Bat News'.

Railway Tunnel Enhancement

Disused railway tunnels can be valuable bat hibernation sites. The Wiltshire Bat Group in England has been managing a project which has increased the value of one such site. Hibernating bats were found in a tunnel during an initial survey in 1993 but conditions were less than ideal, with internal winter temperatures being similar to those outside. In 1994, the ends of the tunnel were sealed and bat access grilles were installed. This succeeded in reducing air movement, maintaining a relatively stable winter temperature of around 8°C, and increasing relative humidity from 80 to 95%.

During the summers of 1994 and 1995 wood was attached to the tunnel walls in order to create crevices suitable for hibernating bats.

The value of all of the hard work carried out is indicated by the increase in the number of bats using the site. Hibernating bat populations have been surveyed three times each winter. At the end of 1993, prior to the construction of the end walls, 117 bats were recorded. By the winter of 1996/97 this number had increased to 190. In the fourteen surveys carried out so far 678 bats have been recorded of which 94% have been Natterer's bats (*M. nattereri*). Other species found include Brown long-eared bat (*P. auritus*), Daubenton's (*M. daubentonii*), Whiskered/Brandt's (*M. mystacinus/brandtii*) and, occasionally, the rare Barbastelle (*B. barbastellus*). Over 30% of hibernating bats are found to be using the crevices formed by the attachment of wood to the tunnel walls.

This successful project has not been carried out in the absence of problems. The end walls have twice been vandalised and damaged once by subsidence after heavy rain. Each occasion has resulted in repairs having to be carried out.

Source: Wiltshire Bat Group, UK.

Converting a pillbox into a hibernaculum

The standard hexagonal pillbox, most common in the south-east of England, can be quickly cheaply and easily converted to a hibernaculum and occasional summer roost for bats. The choice of box for conversion needs some thought; as one of the main threats is disturbance, boxes near to houses, roads or footpaths should be a lower priority than remote boxes on private land. Unconverted sites are often already in use as summer night or feeding roosts, although not normally as day roosts. This means a converted box may be readily adopted, even in its first year.

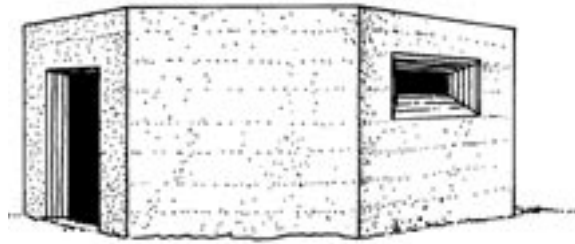
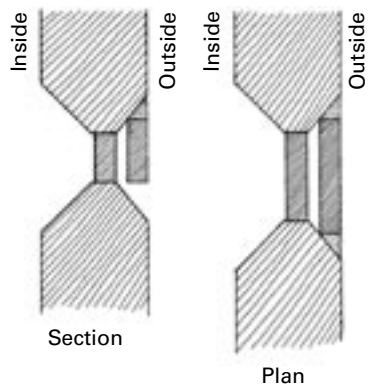

Figure 10. Converting a pillbox to a bat hibernaculum.
a) Pillbox ready for conversion.



b) Blocking the firing slit.

Step 1 – The first requirement is to stabilise the interior temperature, humidity and light levels. Close the firing slits with 100 mm thick medium-density concrete blocks by cementing them, from the inside, into each of the firing slits at their narrowest points (Figure 10b).

Step 2 – Another block is now cemented into the outside, widest, part of each firing slit. Leave a 200 mm by 20 mm gap at the bottom of the cement layer. You have created a hollow between the inner and outer blocks with bat access from the outside.

Step 3 - next, air flow into the building needs to be controlled. Two walls built of 200-250 mm concrete blocks will do this. The first wall should be flush with the outside of the box, up to two thirds of the height of the entrance. The second wall, supported on a lintel, should extend two thirds of the way down from the roof at the innermost point of the entrance passage (Figure 10c). The lintel can be supported on two columns of bricks.

Step 4 - the major part of the conversion is complete, but bats like cracks and a hole to hide in. You must create these well out of the reach of rats and foxes.

Nail wooden boards (Figure 10d) to walls, leaving 15-20 mm narrow gaps between wall and board. The inner shelf of each firing slit can also be built up leaving 20 mm gaps. Tiles can also be nailed to battens on the walls and ceiling to provide further roosting crevices. The more crevices, the greater the possibility that bats will move in.

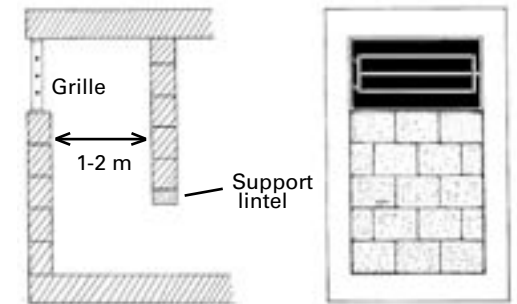

c) Converting the entrance to trap warm air.

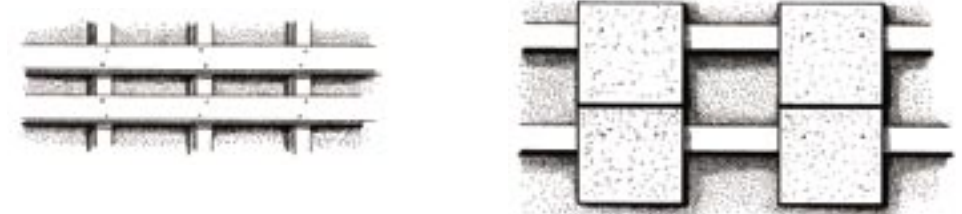

d) Extra roost sites made from battens and tiles.

Step 5 - If a security grille is needed, this can be fitted where the entrance passage is closed by your new wall. The grille should be constructed as described in chapter 4.3.2, using the recommended bar spacing.

The conversion is now complete (Figure 10e).



e) The converted pillbox.

Source: Adapted from Frank Greenaway / Surrey Wildlife Trust, UK.

Case study

Creation of two artificial galleries in Portugal

Several underground bat roosts in abandoned mines, used by *Rhinolophus ferrumequinum*, *R. hipposideros*, *R. mehelyi*, *Myotis myotis*, *M. daubentonii* and *Miniopterus schreibersii* were to be flooded by the construction of large reservoirs at Alqueva and Pedrógão in north-east Portugal. Where important underground sites would be completely lost, replacement galleries were excavated nearby as replacements.

Surveys of the mines to be lost were conducted throughout the year to collect data on patterns of bat usage as well as temperature and humidity, so these could be compared with bat usage and conditions in the replacement galleries.

The first artificial gallery, Moura, was excavated in 1995. It consisted of a curved tunnel about 40m long with a cross section of 1.5 m wide by 2.0 m high, with two connected rooms at the end, allowing the bats to escape in case of disturbance.

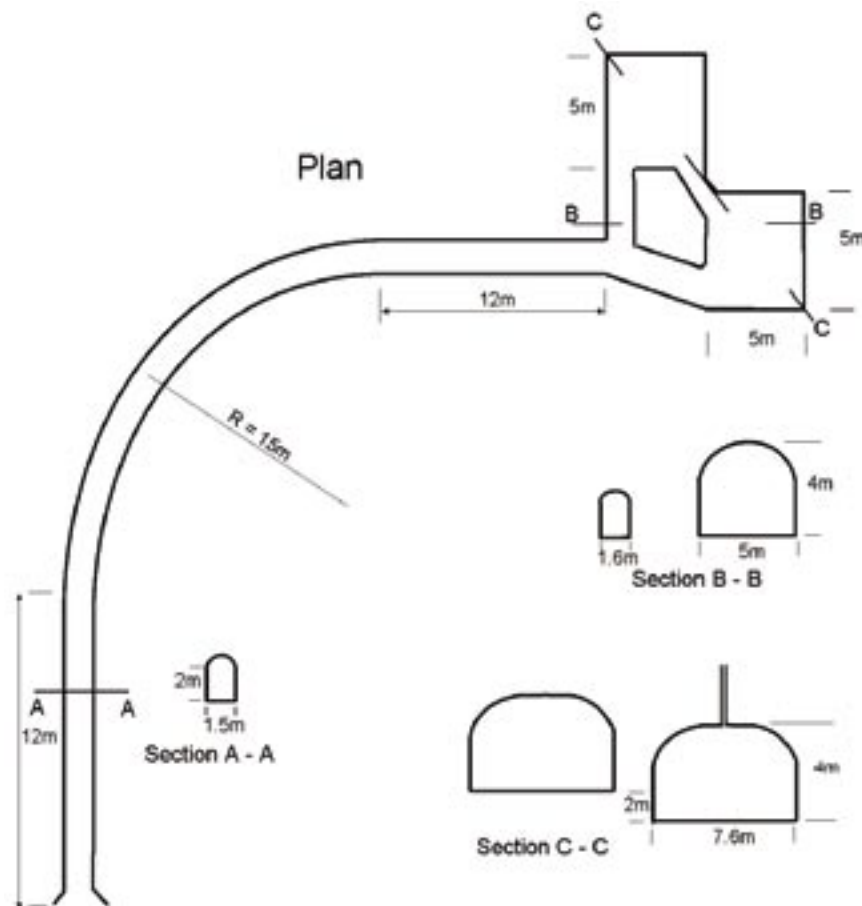
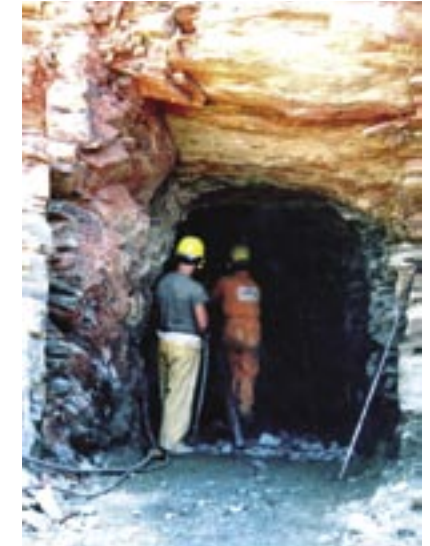

Figure 11. Artificial gallery design, Portugal.

This design was modified slightly when the second gallery, Serpa, was built in 2005. In this case, the two rooms were cut out at different heights, to increase the thermal range, and a hole was drilled in the roof of the lower room to allow any warm air to escape (Figure 11). In addition, a 2.5 m deep ditch was excavated at the entrance to reduce human disturbance.

At Moura, forty-two bats were relocated to the artificial gallery soon after its construction and their original roost was then sealed. Monitoring of the site began early in 1996 and is still continuing. The first bat, a male *M. myotis*, was seen in July of the first year and the first individuals of *R. mehelyi*, *R. ferrumequinum* and *M. schreibersii* were seen in February the following year. Since then, occupation of the site has varied seasonally (Figure 12), with the highest levels of usage by *M. myotis*, *R. mehelyi* and *M. schreibersii*. *M. myotis* has shown a regular pattern of seasonal use since 2001, with the first baby bats observed in 2005. Temperature logging has shown that the



Excavating the Alqueva artificial gallery, Portugal.

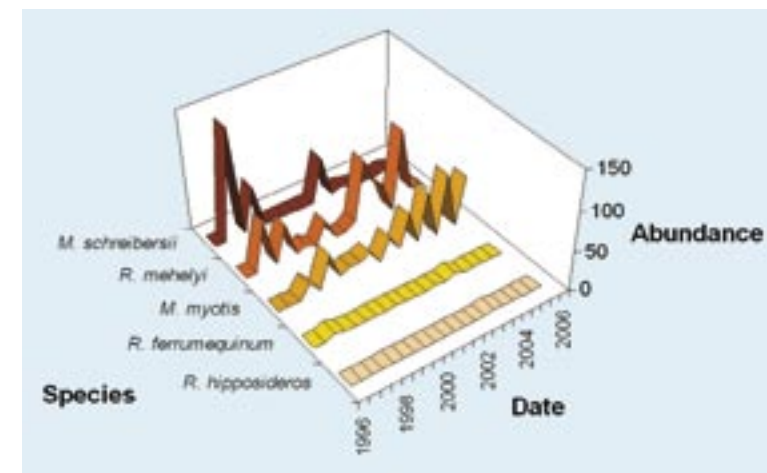

Figure 12. Bat numbers in the artificial gallery.

annual temperature of the roost varies between 16.7 and 19.4°C, probably too high to allow its use as a hibernation site. It is too early to say whether the design changes made to the Serpa tunnel will reduce this temperature. Monitoring of both sites is continuing.

Source: A. Rainho, Instituto da Conservação da Natureza (ICN), Portugal.

7 Monitoring

7.1 Bat monitoring

Counting bats using underground sites can be very difficult and is strongly affected by the species of bats, the layout and type of site, the season and the weather. Many species of bats make extensive use of cracks and crevices for hibernating and breeding, depending on the temperature and air flow of the site. The number of bats visible in sites with extensive crevices may therefore be poorly related to the number of bats present in the site and only an unknown proportion may be seen on any visit. In addition, the proportion visible may be affected by season and temperature and cannot be assumed to be constant. For example, an abandoned stone mine in highly fractured rock may appear to have few bats compared with an abandoned concrete-lined tunnel of similar size and extent, but this may simply be because the bats are not visible in the mine but much more visible in the crevice-free tunnel.



Hibernating Lesser horseshoe bat (Rhinolophus hipposideros), Croatia.



Natterer's bat (Myotis nattereri) and Whiskered/Brandt's bat (Myotis mystacinus/brandtii), Germany.

Despite these difficulties, counting bats in underground sites is widely used as a method of monitoring bats. Although the proportion seen may vary from year to year, it is assumed that over periods of many years this annual variation is smoothed out to reveal underlying trends in numbers.

Bat monitoring visits are best carried out during the daytime, when the bats are least likely to be active. In order to minimise disturbance, the visit should be as short as possible and every effort should be made to avoid unnecessary disturbance.

In many sites, individual bats can be counted and identified to species, but where there are dense colonies of bats it may be necessary to make an estimate of numbers from the area covered and the number of bats per square metre. Low-light photography may be helpful.

7.2 Physical condition

In order to manage the site effectively it is essential that regular checks are made on the condition of the entrances and within the site. Records should be kept of any changes to vegetation around the entrances, roof falls or other changes to the structure of the site and the condition of any physical barriers. Photographs taken from standardised locations can be a quick and easy way of doing this. If changes have occurred, a decision will be required as to whether any management work is required.

Recording the temperature and humidity at various points within the site can provide important information about the impact of any physical changes to the site which may

affect the air flow. Such information can also be used to predict the likely impact of management works and provides a baseline against which future changes can be measured. Mercury thermometers either left in the site or carried in during a visit can give some useful information, but self-contained dataloggers, which can be left in place for long periods, can give a much more detailed profile of the temperature in an underground system and how changes in the external temperature affect the internal temperature. Various types of datalogger are available, the Tinytalk range produced by Gemini (<http://www.gemindataloggers.com/>) or the Hobo range produced by Onset (<http://www.onsetcomp.com>).



Glossary

NGO - Non-governmental organisation. This may include trusts, charities, clubs, societies and similar non-statutory bodies.

SNCO - Statutory nature conservation organisation. The government-funded administrative agency responsible for the application of nature conservation legislation. This may be national, regional or local.

Acknowledgements

Some of the text of this manual is adapted from the Bat worker's manual (see below). Figures 1, 3 (except bottom right), 4, 5, 6, 7 (upper and middle), 9 and 10 are also taken from the Bat worker's manual, courtesy of Natural England, UK. Figure 2 was drawn by S. Roué, CPEPESC, France, and Figures 3 (bottom right) and 7 (bottom) are by Z. Bihari, Hungary. Figures 8, 11 and 12 were supplied by the Instituto da Conservação da Natureza (ICN), Portugal.

Photo credits

Bat Conservation Trust, UK - p. 14 middle
Z. Bihari - p. 27
P. Boye - cover; p. 36
CPEPESC, France - p. 23 upper
C. Harbusch - p. 15 middle and bottom
P. Hope. - p. 21
J. van der Kooij - p. 13
A. J. Mitchell-Jones / Natural England - p. 14 upper and bottom; p. 15 upper; p. 20
A. Rainho - p. 35
L. Rodrigues - p. 23 bottom left and middle right; p. 24; p. 26
N. Tvrtković - p. 23 bottom right

Further reading

Mitchell-Jones, A. J. & McLeish, A. P. (2004): Bat Workers' Manual (3rd edition). JNCC, Peterborough, UK.

Rainho, A., Lourenço, S., Rebelo, H. & Freitas, A. (2006): Bats and Dams – Conservation Actions in the Region of the Reservoirs of Alqueva and Pedrógão. Instituto da Conservação da Natureza, Lisboa.

US Office of Surface Mining, Mid-Continent Region. Bat Conservation and Mining. <http://www.mcrcc.osmre.gov/Bats/Default.htm>